

Rittal – The System.

Faster – better – everywhere.

▶ **Micro Data Center – IT protection
in the smallest possible space**



ENCLOSURES

POWER DISTRIBUTION

CLIMATE CONTROL

IT INFRASTRUCTURE

SOFTWARE & SERVICES



FRIEDHELM LOH GROUP

Rittal – The System.

Faster – better – everywhere.



ENCLOSURES

POWER DISTRIBUTION

CLIMATE CONTROL

FRIEDHELM LOH GROUP

The whole is more than the sum of its parts

The same is true of “Rittal – The System.” With this in mind, we have bundled our innovative enclosure, power distribution, climate control and IT infrastructure products together into a single system platform. Complemented by our extensive range of software tools and global service, we create unique added value for trade and industry: Production plant, test equipment, facility management and data centres. In accordance with our simple principle, “Faster – better – everywhere”, we are able to combine innovative products and efficient service to optimum effect.

Faster – with our “Rittal – The System.” range of modular solutions, which guarantees fast planning, assembly, conversion and commissioning with its system compatibility.

Better – by being quick to translate market trends into products. In this way, our innovative strength helps you to secure competitive advantages.

Everywhere – thanks to global networking:

- 13 production facilities with almost 250,000 m² production space worldwide
- 58 subsidiaries
- Around 90 warehouse facilities with more than 180,000 pallet locations and over 260,000 m² storage space worldwide

IT INFRASTRUCTURE

SOFTWARE & SERVICES



Rittal – The System.

Faster – better – everywhere.



Micro Data Center

In addition to the physical cover in the form of an IT security safe, the configuration components listed below complement the Rittal safe and transform it into a fully fitted Micro Data Center.

- Robust, flexible racks especially for server and network technology
- Efficient cooling solutions in a range of designs and outputs
- IT-specific power distribution
- Networkable monitoring and security solutions with the CMC III system
- Early fire detection and automatic rack extinguishing

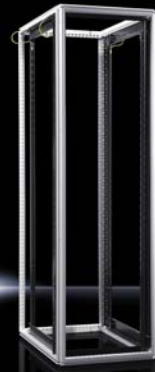

Micro Data Center – Your benefit



- Complete solution in the smallest possible space and in next to no time
- No need for expensive upgrades to existing premises
- Efficient cooling and extinguishing solution

Level E – High level of protection for your IT

- Maximum security in the Micro Data Center product range
- Optimum protection concept for one or more server rack solutions for small and medium-sized enterprises
- Modular layout for installation in hard-to-access locations and for retrospective enclosure of existing IT structures
- Future-proof investment, thanks to the options of extendibility, dismantling and re-assembly
- System-tested security and a high level of protection; testing has been carried out by accredited institutes and confirmed with test reports
- Modified air baffle plates for optimum air routing, for efficient cooling of the Micro Data Centers

Usable U	42/47
Usable interior depth mm	1000/1200
Fire protection	Fire resistance class F 90 to DIN 4102 Part 2, compliance with limits $\Delta T < 50$ K, rel. humidity $< 85\%$ over 30 minutes ¹⁾
Burglar resistance	RC 2 tool attack analogous to DIN EN 1630/2011-09/RC 2 ⁴⁾ RC 3 tool attack analogous to DIN EN 1630/2011-09/RC 3 ³⁾ WK 4 tool attack analogous to DIN V ENV 1630/1999-04/WK 4 ³⁾
Protection category	IP 56 to IEC 60 529 ⁴⁾
Smoke protection	Based on DIN 18 095-2: 1991-03 ⁴⁾
Modularity	■
May be enclosed with the system operational	■
Extendibility	■

¹⁾ The Micro Data Center was tested as a system.

²⁾ The critical connection points were tested as a system.

Micro Data Center – Your benefit



Level B – Solid protection for your IT

- Optimum protection concept for a server rack
- Modular layout for installation in hard-to-access locations
- Form-fit connection with the stable TS 8 framework structure
- Front and rear 482.6 mm (19") level of the TS IT rack already included with the supply
- Lower weight than the Level E Micro Data Center
- Tested security – testing has been carried out by accredited institutes and confirmed with test reports

Solid protection for small IT applications

- Ready-installed safe as a complete system
- Integral cooling
- Integral TS 8 frame structure with front and rear pairs of 482.6 mm (19") mounting angles
- Base/plinth with ground clearance
- Tested security – the tests were carried out as system tests and confirmed via test reports

42/47

15

1000/1200

1000

Fire resistance class EI 90/F 90 to DIN EN 1363-1: 1999 / based on DIN 4102-2:1997²⁾

Fire resistance class F 90 to DIN 4102 Part 2, compliance with limits $\Delta T < 50$ K, rel. humidity $< 85\%$ over 10 minutes¹⁾

RC 2 tool attack analogous to DIN EN 1630/2011-09/RC 2³⁾

WK 2 tool attack analogous to DIN V ENV 1630/1999-04/WK 2¹⁾

IP 56 to IEC 60 529: 2000³⁾

IP 55 to IEC 60 529¹⁾

Based on DIN EN 1634-3: 2005-01³⁾

–

■

Safe is supplied assembled including cooling unit

–

–

–

–

³⁾ The safe for stand-alone siting was tested as a system with single-leaf doors and mechanical lock.

⁴⁾ The safe for stand-alone siting was tested as a system with one single-leaf door and one bifold door and mechanical lock.

Micro Data Center Level E



System accessories Cat. 34, page 507

Applications:

- A high level of protection against potential physical threats for IT
- Targeted configuration components complete it to a Micro Data Center

Benefits:

- As well as facilitating installation in poorly accessible sites, the modular design also makes it possible to retrospectively enclose existing IT structures.
- Extendibility, dismantling and re-assembly mean targeted, future-safe investments
- Tested security – testing has been carried out by accredited institutes and confirmed with test reports

Protection standards:

- Fire protection category F 90 to DIN 4102 Part 2
- Compliance with limit values $\Delta T < 50$ K, relative humidity $< 85\%$ for 30 minutes
- Burglary resistance RC 2, optionally RC 3, tool attack analogous to DIN EN 1630/2011-09 and optionally WK 4, tool attack analogous to DIN V ENV 1630/1999-04/WK 2
- Smoke protection based on DIN 18 095-2: 1991-03

Material:

- Sheet steel, coated

Colour:

- Enclosure and service door: RAL 7035
- Operator door: RAL 9005

Protection category IP to IEC 60 529:

- IP 56

Supply includes:

- Micro Data Center with operator door and service door
- Cable entry in both side elements
- Both doors with key lock

Optional:

- Choice of door hinges
- Bifold doors
- Different cable entry systems
- Cable entry additionally in the top or base unit
- Different lock variants
- Supporting structure

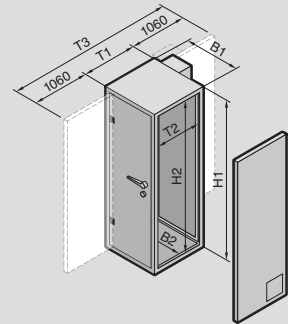

Note:

- The Micro Data Center is configured on a project-specific basis

Further technical information:

Available on the Internet

U		42	47	42	47
External dimensions mm	Width (B1)	1100	1100	1100	1100
	Height (H1)	2210	2410	2210	2410
	Depth (T1)	1200	1200	1400	1400
	Depth (T3)	3320	3320	3520	3520
Internal dimensions mm	Width (B2)	920	920	920	920
	Height (H2)	2030	2230	2030	2230
	Depth (T2)	1000	1000	1200	1200
Model no. (Safe is configured on a project-specific basis)		7999.009	7999.009	7999.009	7999.009
Empty weight excluding cooling unit and excluding rack approx. kg		660	700	730	800
Accessories					
Fire alarm and extinguisher system DET-AC/EFD III		see page 18	see page 18	see page 18	see page 18
CMC III monitoring system		see page 21	see page 21	see page 21	see page 21
PSM – Power System Module busbar		see Cat. 34, page 409	see Cat. 34, page 409	see Cat. 34, page 409	see Cat. 34, page 409
PDU – Power Distribution Unit		see page 22	see page 22	see page 22	see page 22
Split cooling solutions		see page 13	see page 13	see page 13	see page 13
LCP – Liquid Cooling Unit		see page 14	see page 14	see page 14	see page 14

Standard protection from:



Fire



Extinguishing water



Corrosive gases



Vandalism



Unauthorised access



Dust



Theft/burglary

Options Micro Data Center Level E

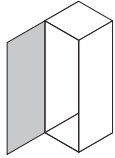
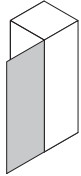
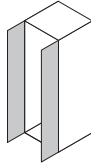
Operator door	L/h DIN door hinge	R/h DIN door hinge	Bifold door
			
	■	□	□

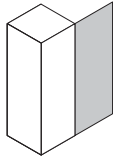
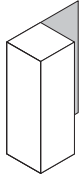
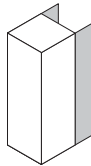

Service door	L/h DIN door hinge	R/h DIN door hinge	Bifold door
			
	■	□	□

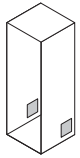
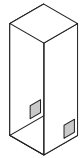
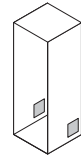
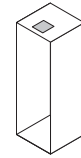
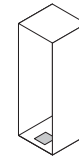
Cable entry	Soft duct ¹⁾ in both side elements	Hard duct ²⁾ in both side elements	Cable box ³⁾ in both side elements	Hard duct ²⁾ in top element	Hard duct ²⁾ in base element
					
	■	□	□	□	□



¹⁾ Size of soft duct: approx. 267 x 165 mm
For fire protection reasons, the duct may be configured up to a max. of 60% with cable up to a diameter of 15 mm and conduits up to a diameter of 18 mm.

²⁾ Size of hard duct: 2 panels each 120 x 120 mm
Cables up to a diameter of 15 mm may be routed through the hard duct.

³⁾ Size of cable box: Cables up to a diameter of 15 mm and hoses up to a diameter of 44 mm may be routed through the cable box. No conduits may be routed through the cable box.

Locks	Key lock with 2 keys	Electronic combination lock ¹⁾	Electronic combination lock for activation via an access control system supplied by the customer
	■	□	□

¹⁾ First code, second code and double code allocation possible. Key-based opening for inspection purposes supported.

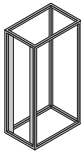
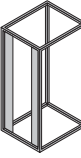

TS IT rack with air baffle plates								
	600				800			
Width mm								
Height mm	2000	2200	2000	2200	2000	2200	2000	2200
Depth mm	1000	1000	1200	1200	1000	1000	1200	1200
	□	□	□	□	□	□	□	□

■ Included with the supply □ Optional

Supporting structure	Steel supporting structure to compensate for the raised floor height when siting the modular safe on the bare floor. The height of the supporting structure is selectable between 100 mm and 1000 mm.	Steel supporting structure to compensate for the raised floor height when siting the modular safe on the bare floor. The supporting structure has a fire-proof covering. The height of the supporting structure is selectable between 100 mm and 1000 mm.
	□	□

■ Included with the supply □ Optional



Micro Data Center Level B



System accessories Cat. 34, page 507

Applications:

- Basic protection against potential physical threats for IT components. Targeted configuration components transform the safe into a complete Micro Data Center.

Benefits:

- Modular layout for installation in hard-to-access locations
- Lower weight than the Level E Micro Data Center
- Tested security – testing has been carried out by accredited institutes and confirmed with test reports

Protection standards:

- Fire protection – fire resistance class EI 90/F 90 to DIN EN 1363-1: 1999 based on DIN EN 4102-2: 1997
- Burglar resistance RC 2 Tool attack analogous to DIN EN 1630/2011-09/RC 2
- Smoke protection based on DIN EN 18 1634-3: 2005-01

Material:

- Sheet steel, coated

Colour:

- Enclosure and service door: RAL 7035
- Operator door: RAL 9005

Protection category IP to IEC 60 529:

- IP 56

Supply includes:

- Security safe with integral TS 8 frame
- Front and rear 482.6 mm (19") level
- Adjusted air baffle plates
- Every side element is prepared for one cable entry at the bottom and one cable entry at the top
- Operator and service door with swing-lever handle and semi-cylinder

Optional:

- Choice of door hinges
- Bifold doors
- Different cable entry systems
- Cable entry additionally in the top and base element
- Different lock variants
- Supporting structure with fire protection

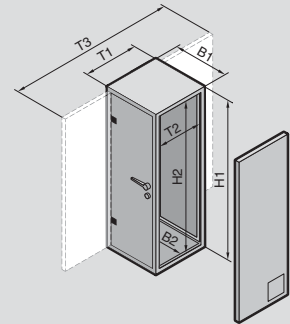

Note:

- The Micro Data Center is configured on a project-specific basis

Further technical information:

Available on the Internet

U		42	47	42	47
External dimensions mm	Width (B1)	1115	1115	1115	1115
	Height (H1)	2205	2405	2205	2405
	Depth (T1)	1377	1377	1577	1577
	Depth (T3)	3274	3274	3474	3474
Internal dimensions mm	Width (B2)	905	905	905	905
	Height (H2)	2000	2200	2000	2200
	Depth (T2)	1060	1060	1260	1260
Model no. (Safe is configured on a project-specific basis)		7999.709	7999.709	7999.709	7999.709
Empty weight excluding cooling unit ca. kg		595	630	660	700

Accessories

Fire alarm and extinguisher system DET-AC/EFD III	see page 18	see page 18	see page 18	see page 18
CMC III monitoring system	see page 21	see page 21	see page 21	see page 21
PSM – Power System Module busbar	see Cat. 34, page 409	see Cat. 34, page 409	see Cat. 34, page 409	see Cat. 34, page 409
PDU – Power Distribution Unit	see page 22	see page 22	see page 22	see page 22
Split cooling solutions	see page 13	see page 13	see page 13	see page 13
LCP – Liquid Cooling Unit	see page 14	see page 14	see page 14	see page 14

Standard protection from:



Fire



Extinguishing water



Corrosive gases



Vandalism



Unauthorised access



Dust



Theft/burglary

Options Micro Data Center Level B

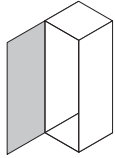
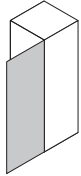
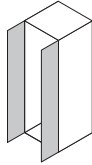
Operator door	L/h DIN door hinge	R/h DIN door hinge	Bifold door
			
	■	□	□

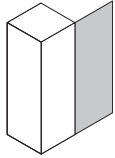
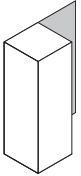
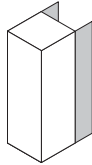

Service door	L/h DIN door hinge	R/h DIN door hinge	Bifold door
			
	■	□	□

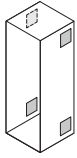
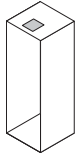
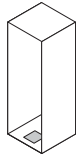
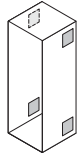

Cable entry	Soft duct ¹⁾ in both side elements	Cable box ²⁾ in top element	Cable box ²⁾ in base element	Cable box ²⁾ in both side elements
				
	■	□	□	□



¹⁾ Size of soft duct: approx. 267 x 165 mm
For fire protection reasons, the duct may be configured up to a max. of 60% with cable up to a diameter of 15 mm and conduits up to a diameter of 18 mm.

²⁾ Size of cable box: Cables up to a diameter of 15 mm and hoses up to a diameter of 44 mm may be routed through the cable box. No conduits may be routed through the cable box.

Locks	Swing lever handle with interchangeable semi-cylinder	Swing lever handle with electronic lock for external activation	Swing lever handle with electronic lock with combination code
	■	□	□



Supporting structure	Steel supporting structure to compensate for the raised floor height when siting the modular safe on the bare floor. The supporting structure has a fire-proof covering. The height of the supporting structure is selectable between 100 mm and 1000 mm.		
	□	□	□

■ Included with the supply □ Optional

Micro Data Center Level A



System accessories Cat. 34, page 507

Applications:

- Protection for servers and storage applications
- Protection for business-critical data
- Storage of personal data, e.g. doctors' surgeries or tax advisors

Benefits:

- Complete system with built-in cooling and 482.6 mm (19") rack
- High level of operational and service-friendliness thanks to the two-door system
- Compatibility with other infrastructure elements
- Tested security – testing has been carried out by accredited institutes and confirmed with test reports

Protection standards:

- Fire resistance class F 90 to DIN 4102 Part 2, compliance with limits $\Delta T < 50$ K, rel. humidity $< 85\%$ over 10 minutes
- Burglar resistance WK 2 Tool attack analogous to DIN V ENV 1630/1999-04/WK 2

Material:

- Sheet steel, coated

Colour:

- Enclosure and service door: RAL 7035
- Operator door: RAL 9005

Protection category IP to IEC 60 529:

- IP 55

Supply includes:

- Security enclosure with operating and service doors (three-point locking)
- Cable entry in both side elements
- Cooling 2.4 kW designed as a split unit

Further technical information:

Available on the Internet.

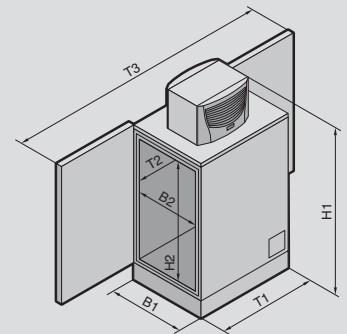

U		15
Cooling output kW		2.4
External dimensions mm	Width (B1)	806
	Height (H1)	1699
	Depth (T1)	1270
	Depth (T3)	2746
Internal dimensions mm	Width (B2)	620
	Height (H2)	827
	Depth (T2)	1024
Weight excluding internal fittings, including climate control unit approx. kg		360
Model No. Micro Data Center with built-in 482.6 mm (19") rack		7999.999
Model No. Micro Data Center without built-in 482.6 mm (19") rack		7999.898
Accessories		
482.6 mm (19") rack, 15 U, depth 1000 mm		7995.992
Fire alarm and extinguisher system DET-AC/EFD III		see page 18
CMC III monitoring system		see page 21
PDU – Power Distribution Unit with busbar		see page 22

Standard protection from:



Fire



Extinguishing water



Vandalism



Unauthorised access



Dust



Theft/burglary



Micro Data Center from page 8

For cooling the Micro Data Center Level B and Level E. The split cooling unit is comprised of an internal unit (evaporator coil) and an external unit, whereby the internal unit is secured to the side panel on the inside of the Micro Data Center, and the external unit to the service door.

Benefits:

- Separate, hermetically sealed internal and external circuits
- Dust and flue gas are unable to ingress
- The internal and external unit are connected to one another via refrigerant lines and control cables and shielded for fire protection
- Air routing in the Micro Data Center is horizontal. Modified air baffle plates ensure targeted air routing. By separating the "cold side" from the "hot side", air short-circuits are avoided, and the efficiency of cooling is enhanced.

Temperature control:

- Comfort controller (factory setting +25°C)

Colour:

- RAL 7035

Protection category IP to IEC 60 529:

- IP 24

Supply includes:

- Internal unit (evaporator coil)
- External unit
- Refrigerant lines
- Data and supply cables

Further technical information:

Available on the Internet

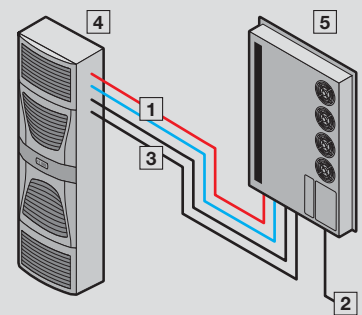

- 1** Flexible refrigerant lines inlet/return
- 2** Power supply
- 3** Data cable
- 4** External unit
- 5** Internal unit

for Micro Data Center

Model No.	3126.230	Page
Weight kg	160.0	
Dimensions W x H x D, external unit mm	500 x 1580 x 231	
Dimensions W x H x D, internal unit mm	804 x 1544 x 100	
Total cooling output 50/60 Hz L35 L35 W	2500 / 3090	
Total cooling output 50/60 Hz L35 L50 W	2070 / 2300	
Power consumption P _{el} 50/60 Hz L35 L35 W	1275 / 1615	
Power consumption P _{el} 50/60 Hz L35 L50 W	1525 / 1920	
Rated operating voltage V, ~, Hz	400, 3~, 50 460, 3~, 60	
Rated max. current A	3.3 / 3.5	
Start-up current A	14.2 / 14.7	
Pre-fuse A	6.3 / 10	
Motor circuit-breaker	■	
Refrigeration factor $\epsilon = Q_{kr}/P_{el}$	2	
Refrigerant g	R134a, 1500	
Permissible operating pressure (p max.) bar	28	
Operating temperature range	+20°C...+55°C	
Noise level max. dB(A)	70	

Liquid Cooling Unit



TS IT network/server enclosures see Innovations brochure **Micro Data Center** from page 8

Applications:

- Cooling unit for TS IT server enclosures and for Micro Data Center

Benefits:

- Space-saving solution by installing the internal unit in the TS IT server enclosure or the Micro Data Center
- Maximum energy efficiency due to EC fan technology and IT-based control
- Control of the server inlet temperature
- The inverter-controlled compressor adapts the cooling output to the current heat loss inside the enclosure
- Absorbed thermal energy is emitted directly to the ambient air at the (inverter-controlled) external unit's location, without heating up the installation room

Functions:

- The device supports "front to back" air routing typical of IT applications, and regulates the server inlet temperature to the set value

Colour:

- Internal unit: RAL 7035
- External unit: white

Protection category IP to IEC 60 529:

- Internal unit IP 20
- External unit IP X4

Supply includes:

- Internal unit (evaporator coil)
- External unit (inverter-controlled)
- 482.6 mm (19") mounting trim panel with display and control components
- Condensate hose

Note:

- Below the operating limit, fluctuations in the air inlet temperature are possible
- The electrical connection is made on the external unit; the internal unit is supplied by the external unit

Installation in TS IT:

- 482.6 mm (19") levels must be designed as mounting angles and offset in the width by 50 mm off-centre
- The front distance between the 482.6 mm (19") mounting angles and the front edge of the TS frame must be at least 100 mm
- Not suitable for combination with 482.6 mm (19") mounting frame
- Two punched sections with mounting flanges are required for attachment on the inner mounting level
- To separate the hot/cold zones within an enclosure, an air baffle plate for TS IT is required
- A Flex-Block base/plinth is required to route the cable downwards

Further technical information:

Available on the Internet

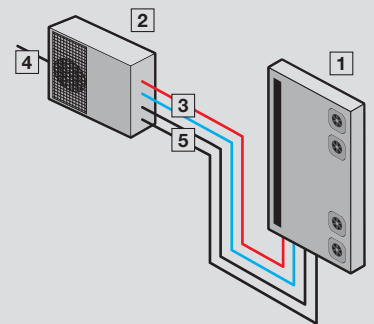

- 1 Internal unit
- 2 External unit
- 3 Refrigerant lines
- 4 Power supply
- 5 Data cable

LCU DX, single

Design	Packs of	LCU DX 3 kW	LCU DX 6.5 kW	Page
Model No.	1 pc(s).	3311.490	3311.492	
For enclosure width mm		= 800	= 800	
For enclosure height mm		≥ 1800	≥ 1800	
For enclosure depth mm		≥ 1000	≥ 1000	
External unit, W x H x D mm		810 x 558 x 310	845 x 700 x 320	
Internal unit, W x H x D mm		105 x 1550 x 820	105 x 1550 x 820	
Type of electrical connection		Connection clamp	Connection clamp	
Rated operating voltage V, ~, Hz		230, 1~, 50	230, 1~, 50	
Rated current (max.) A		7	15.9	
Pre-fuse A		16	20	
Duty cycle %		100	100	
Useful cooling output L22 L35 kW		3	6.5	
Cooling medium		R410a	R410a	
Sound pressure level at a distance of 10 m (external unit) dB(A)		40	40	
Operating temperature range (external unit)		-20°C...+45°C	-20°C...+45°C	
Weight as delivered kg		116.0	126.0	
Accessories				
Refrigerant lines	1 pc(s).	3311.495	3311.496	

Any questions about our services or maintenance agreements?

Do you need an individual, personal consultation or a service quote? Our service specialists will be happy to assist you.

- Manufacturers' warranty
- Configuration and assembly
- Inspection
- Climate control pipework
- Commissioning
- Leak test
- Modernisation
- Maintenance
- Service agreements (SLA)
- Spare parts
- Response time
- Wearing parts

Please direct enquiries to the local Rittal Service organisation, either by e-mail or phone. www.rittal.com/contact

Rittal Service

CMC III Processing Unit/Compact



www.rittal.com/r?!cu-cmc3-en

CMC III

Liquid Cooling Unit



TS IT network/server enclosures see Innovations brochure **Micro Data Center** from page 8

Applications:

- Cooling unit for TS IT server enclosures and for Micro Data Center in a redundant design

Benefits:

- Space-saving solution by installing the redundantly designed internal unit in the TS IT server enclosure or the Micro Data Center
- Maximum energy efficiency due to EC fan technology and IT-based control
- Control of the server inlet temperature
- The inverter-controlled compressor adapts the cooling output to the current heat loss inside the enclosure
- Absorbed thermal energy is emitted directly to the ambient air at the (inverter-controlled) external unit's location, without heating up the installation room

Functions:

- The redundant variants have two cooling circuits and controllers inside the internal unit, plus two inverter-regulated external units. The fault and operating hours changeover allows regular switching between the two external units, and ensures automatic changeover in the event of a malfunction or failure.
- The device supports "front to back" air routing typical of IT applications, and regulates the server inlet temperature to the set value

Protection category IP to IEC 60 529:

- External unit IP X4
- Internal unit IP 20

Supply includes:

- Internal unit (evaporator coil)
- 2 external units (inverter-controlled)
- 482.6 mm (19') mounting trim panel with display and control components
- Condensate hose

Note:

- Below the operating limit, fluctuations in the air inlet temperature are possible
- The electrical connection is made on the external unit; the internal unit is supplied by the external unit
- A separate power supply may be needed, depending on the external unit

Installation in TS IT:

- 482.6 mm (19') levels must be designed as mounting angles and offset in the width by 50 mm off-centre
- The front distance between the 482.6 mm (19') mounting angles and the front edge of the TS frame must be at least 100 mm
- Not suitable for combination with 482.6 mm (19') mounting frame
- Two punched sections with mounting flanges are required for attachment on the inner mounting level
- To separate the hot/cold zones within an enclosure, an air baffle plate for TS IT is required
- A Flex-Block base/plinth is required to route the cable downwards

Further technical information:

Available on the Internet

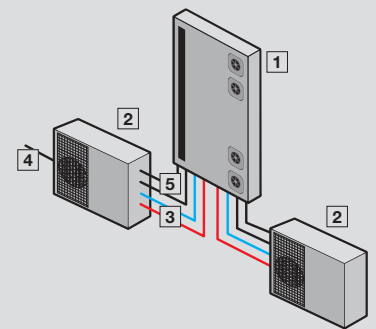

- 1 Internal unit
- 2 External unit
- 3 Refrigerant lines
- 4 Power supply
- 5 Data cable

LCU DX, redundant

Design	Packs of	LCU DX 3 kW redundant	LCU DX 6.5 kW redundant	Page
Model No.	1 pc(s).	3311.491	3311.493	
For enclosure width mm		= 800	= 800	
For enclosure height mm		≥ 1800	≥ 1800	
For enclosure depth mm		≥ 1000	≥ 1000	
External unit, W x H x D mm		810 x 558 x 310	845 x 700 x 320	
Internal unit, W x H x D mm		105 x 1550 x 820	105 x 1550 x 820	
Type of electrical connection		Connection clamp	Connection clamp	
Rated operating voltage V, ~, Hz		230, 1~, 50	230, 1~, 50	
Rated current (max.) A		7	15.9	
Pre-fuse A		16	20	
Duty cycle %		100	100	
Useful cooling output L22 L35 kW		3	6.5	
Cooling medium		R410a	R410a	
Sound pressure level at a distance of 10 m (external unit) dB(A)		40	40	
Operating temperature range (external unit)		-20°C...+45°C	-20°C...+45°C	
Weight as delivered kg		154.0	174.0	
Accessories				
Refrigerant lines	1 pc(s).	3311.495	3311.496	

Rittal data centre health check – know what’s going on!

Rittal Service

On request, as part of a maintenance order or service agreement, we will carry out the following health check on your data centre, free of charge:

- Perform an evaluation
- Assess the risk
- Highlight potential savings
- Offer solutions

Please direct enquiries to the local Rittal Service organisation, either by e-mail or phone. www.rittal.com/contact

Power Distribution Unit



PDU – Power Distribution Unit



www.rittal.com/r?lcu-pdu-en

Fire alarm and extinguisher system



System accessories Cat. 34, page 507 **TS IT network/server enclosures** see Innovations brochure

The active extinguisher system includes the smoke extraction system and the extinguisher unit. The smoke extraction system is identical to the smoke extraction system in the EFD III. The extinguishing process begins automatically when a main alarm is activated. For the extinguishing process, the tank is pressurised via a propellant cartridge. The extinguisher gas Novec™ 1230 evaporates at the extinguisher nozzle and is distributed in the server enclosure.

Benefits:

- Early fire detection
- Automatic extinguishing
- Innovative extinguisher NOVEC™ 1230: eco-friendly, non-critical for IT components, non-conductive
- 482.6 mm (19") rack mount with just 1 U
- Tested by VdS Schadenverhütung GmbH
- CAN bus interface to CMC III monitoring system
- Floating relay outputs (pre-alarm/main alarm/collective fault)

Material:

- Sheet steel

Colour:

- Enclosure: RAL 7035
- Front: RAL 9005

Protection category IP to IEC 60 529:

- IP 30

Note:

- The systems is designed solely for use in closed, non-accessible enclosure systems with a maximum volume of 2.8 m³.

Further technical information:

Available on the Internet

DET-AC III Master

Width mm	Packs of	482.6	Cat. 34, page
Height mm		44	
Depth mm		660	
Weight kg		22.1	
Model No.	1 pc(s).	7338.121	
Operating temperature range		+10°C...+40°C	
Storage temperature range without batteries		-20°C...+65°C	
Storage temperature range of batteries		-15°C...+40°C	
Ambient humidity (non-condensing) %		96	
Rated operating voltage V, ~, Hz		100 – 240, 1~, 50/60	
Emergency power supply		approx. 4 h	
Airflow monitoring		approx. ±10% of total airflow	
Interfaces		4x/3x relay outputs for alarms and faults (terminals/RJ12 jacks) 1x/1x input for door contact switch (terminal/RJ12 jack) 2 x CAN connections for master-slave networking 2x connection (external alarm/manual call point) 1 x voltage output for DET-AC slave III (24 V DC max. 500 mA) 1 x USB 2 x CAN bus interfaces to CMC III (max. 16 on PU/4 on PU Compact)	
Sensors		Optical smoke detector (sensitivity: approx. 3.5%/m light obscuration) Optical smoke detector HS (sensitivity: approx. 0.25%/m light obscuration)	
Display		Plain-language display with 6 LEDs	
Technical specifications		Extinguisher is emitted via a propellant cartridge, with integral electrical activation unit Integral extinguisher monitoring (indication of >15% loss)	
Tank: Material/volume l		Aluminium / 2	
Extinguisher: Type/fill volume l		NOVEC™ 1230 / 1.8	

Also required

CMC III sensors	2 pc(s).	7320.530	455
CMC III CAN bus connection cable	1 pc(s).	7030.091	457
Pipe kit	1 pc(s).	7338.130	
Slide rails, depth-variable	2 pc(s).	5501.480	687

Early fire detection system



System accessories Cat. 34, page 507 **TS IT network/server enclosures** see Innovations brochure

The EFD III early fire detection system includes the smoke extraction system in a 482.6 mm (19") subrack with just 1 U. An integral fan continuously extracts air from the area being protected via a system of pipes. The air drawn in passes two fire detectors. If smoke is detected, the highly sensitive detector will emit a pre-alarm, while the second detector will activate the main alarm. The fire detectors are permanently monitored for correct functioning by the evaluation and control electronics on the control card.

Benefits:

- Early fire detection
- 482.6 mm (19") rack mount with just 1 U
- Tested by VdS Schadenverhütung GmbH
- CAN bus interface to CMC III monitoring system
- Floating relay outputs (pre-alarm/main alarm/collective fault)

Material:

- Sheet steel

Colour:

- Enclosure: RAL 7035
- Front: RAL 9005

Protection category IP to IEC 60 529:

- IP 30

Note:

- This system is designed solely for use in closed, non-accessible enclosure systems.

Further technical information:

Available on the Internet

EFD III

Width mm	Packs of	482.6	Cat. 34, page
Height mm		44	
Depth mm		490	
Weight kg		15.0	
Model No.	1 pc(s).	7338.221	
Operating temperature range		+10°C...+40°C	
Storage temperature range without batteries		-20°C...+65°C	
Storage temperature range of batteries		-15°C...+40°C	
Ambient humidity (non-condensing) %		96	
Rated operating voltage V, ~, Hz		100 – 240, 1~, 50/60	
Emergency power supply		approx. 4 h	
Airflow monitoring		approx. ±10% of total airflow	
Interfaces		4x/3x relay outputs for alarms and faults (terminals/RJ12 jacks) 1x/1x input for door contact switch (terminal/RJ12 jack) 2 x CAN connections for master-slave networking 3 x connection (external alarm/manual call point/tank and fill level) 1 x voltage output for DET-AC slave III (24 V DC max. 500 mA) 1 x USB 2 x CAN bus interfaces to CMC III (max. 16 on PU/4 on PU Compact)	
Sensors		Optical smoke detector (sensitivity: approx. 3.5%/m light obscuration) Optical smoke detector HS (sensitivity: approx. 0.25%/m light obscuration)	
Display		Plain-language display with 6 LEDs	

Also required

CMC III CAN bus connection cable	1 pc(s).	7030.091	457
Pipe kit	1 pc(s).	7338.130	
Slide rails, depth-variable	2 pc(s).	5501.480	687

Add-on unit



System accessories Cat. 34, page 507 **TS IT network/server enclosures** see Innovations brochure

This add-on unit to the DET AC III Master includes an additional extinguisher unit. In addition to the DET-AC III unit, a DET-AC III slave unit is used for each additional bayed enclosure and supplies the extinguishing agent for that enclosure. Detection occurs via the DET-AC III master system, even when multiple enclosures are bayed together. If a main alarm is reported, the DET-AC III Master will activate extinguishing in all systems simultaneously.

Benefits:

- Innovative extinguisher NOVEC™ 1230: eco-friendly, non-critical for IT components, non-conductive
- 482.6 mm (19") rack mount with just 1 U
- Tested by VdS Schadenverhütung GmbH
- CAN bus interface to CMC III monitoring system
- In conjunction with the DET-AC III Master, extinguishes up to five racks in an enclosure suite
- May be used in combination with EFD III
- Floating relay outputs (pre-alarm/main alarm/collective fault)

Material:

- Sheet steel

Colour:

- Enclosure: RAL 7035
- Front: RAL 9005

Protection category IP to IEC 60 529:

- IP 30

Note:

- This system is designed solely for use in closed, non-accessible enclosure systems with a maximum volume of 2.8 m³.

Further technical information:

Available on the Internet

DET-AC III Slave

Width mm	Packs of	482.6	Cat. 34, page
Height mm		44	
Depth mm		660	
Weight kg		19.1	
Model No.	1 pc(s).	7338.321	
Operating temperature range		+10°C...+40°C	
Storage temperature range without batteries		-20°C...+65°C	
Storage temperature range of batteries		-15°C...+40°C	
Ambient humidity (non-condensing) %		96	
Rated operating voltage V		24 (DC)	
Emergency power supply		approx. 4 h	
Interfaces		4x/3x relay outputs for alarms and faults (terminals/RJ12 jacks) 1x/1x input for door contact switch (terminal/RJ12 jack) 2 x CAN connections for master-slave networking 2x connection (external alarm/manual call point) 1 x voltage output for DET-AC slave III (24 V DC max. 500 mA) 1 x USB 2 x CAN bus interfaces to CMC III (max. 16 on PU/4 on PU Compact)	
Technical specifications		Extinguisher is emitted via a propellant cartridge, with integral electrical activation unit Integral extinguisher monitoring (indication of >15 % loss)	
Tank: Material/volume l		Aluminium / 2	
Extinguisher: Type/fill volume l		NOVEC™ 1230 / 1.8	
Also required			
CMC III sensors	2 pc(s).	7320.530	455
Pipe kit	1 pc(s).	7338.130	
Slide rails, depth-variable	2 pc(s).	5501.480	687

CMC III monitoring system

CMC III monitoring system

The CMC III monitoring system controls physical parameters such as the temperature inside the Micro Data Center.

The user defines limits for the various parameters. These are fully automatically monitored by the CMC. If the limits are exceeded or undercut, the CMC emits an alarm which may optionally be notified via e-mail or SMS.

The system may also be connected to the customer network (via OPC/SNMP) to represent messages or values directly in the control room system (SCADA/BMS/NMS).

The CMC III system is plug & play-ready, sensors are detected automatically, and the Web user interface is easy to use even with no prior knowledge.

The CMC III Processing Unit Compact (basic unit) is available for small monitoring units, and supports the connection of up to four sensors. The CMC III Processing Unit for larger monitoring units supports the connection of up to 32 sensors.

There is a 24 V DC power supply with a redundant design, but power can also be supplied via the integral Power over Ethernet (PoE).

In addition to temperature monitoring, both the alarms and collective fault signal from the fire alarm and extinguishing system, as well as the fault signalling from the climate control system, may be switched to the CMC.

	Packs of	Model No.
CMC III Processing Unit Compact	1	7030.010
Power pack 100 – 240 V AC to 24 V DC	1	7030.060
Mounting unit, 1 U	1	7030.070
USB programming cable	1	7030.080
CAN bus cable 0.5 m	5	7030.090
CAN bus cable 1.0 m	1	7030.091
CAN bus unit for CMC-TC sensors	3	7030.100
Temperature sensor	1	7030.110
Connection cable	1	7200.210

Note:

For more CMC III sensors, see Catalogue 34, page 454.



Application example for monitoring a Micro Data Center with fire alarm and extinguisher system

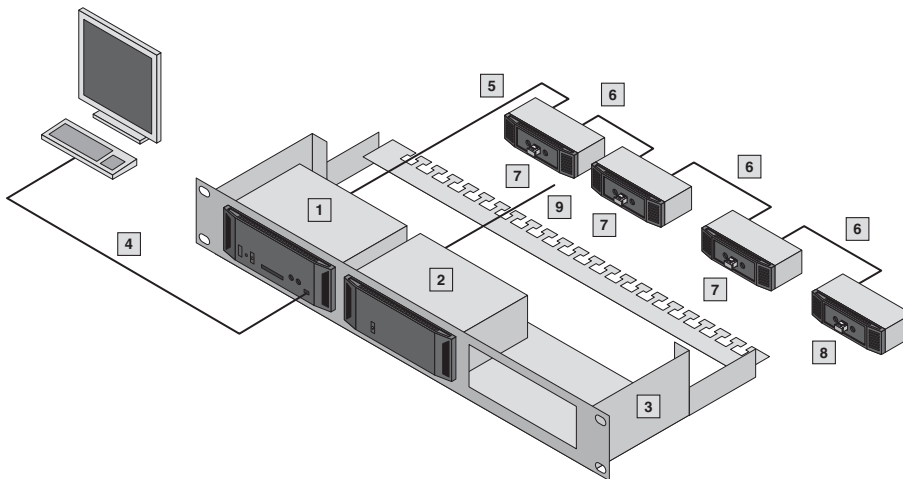

- 1 CMC III Processing Unit Compact
(with front infrared access sensor, temperature sensor, 2/1 inputs/outputs)
- 2 Power pack 100 – 240 V AC to 24 V DC
- 3 Mounting unit, 1 U
- 4 USB programming cable
- 5 CAN bus connection cable 1 m
- 6 CAN bus connection cable 0.5 m
- 7 CAN bus sensor
- 8 Temperature sensor
- 9 Connection cable

Power Distribution Unit



Power Distribution Unit

Benefits:

- With the compact PDU, any IT rack may be easily equipped with a professional power distribution system
- With the TS IT rack, assembly is even tool-free
- Compact design
- Easy to assemble
- Power-saving design, minimal inherent consumption by the PDU itself, thanks to the use of bistable relays and OLED display with power-saving function
- Integral web server for direct network connection with extensive user administration (not PDU basic/slave PDU)
- Redundant power supply from all 3 phases and additionally via an existing PoE (Power over Ethernet) network
- Extensive range of management and monitoring functions
- High-MTBF and measurement accuracy of 1%
- CAN bus for connecting slave PDUs (not PDU basic)
- Ambient monitoring with up to 4 CMC III sensors (temperature, humidity, access, vandalism)

PDU design variants:

PDU basic

Robust, compact basic power distributor for the IT environment

PDU metered

Energy measurement per phase, i.e. output requirement of an entire IT rack

PDU switched

Measurement function per phase and individually switchable output slots

PDU managed

High-end IT rack, power distribution with energy measurement and monitoring functions for each individual output slot

Material:

- Extruded aluminium section, black

Protection category IP to IEC 60 529:

- IP 20

Standards:

- EN 60 950
- EN 61 000-4
- EN 61 000-6
- EN 55 022

Low Voltage Directive:

- 2014/35/EU

EMC directive:

- 2014/30/EU

Photo shows a configuration example with equipment not included in the scope of supply

PDU international, basic version

Power			Pin patterns			Dimensions		Model No.
No. of phases	Phase current A	Output kW	Input	Outputs C13	Outputs C19	PDU length mm	Minimum enclosure height mm	
1	16	3.6	CEE	24	4	970	1200	7955.110
1	32	7.2	CEE	24	4	1115	1800	7955.111
3	16	11	CEE	18	3	845	1200	7955.131
3	16	11	CEE	24	6	1145	1800	7955.132
3	32	22	CEE	24	6	1365	1800	7955.133
3	32	22	CEE	36	6	1710	2000	7955.134
3	16	11	CEE	42	–	1405	1800	7955.135

PDU international, metered version

Power			Pin patterns			Dimensions		Model No.
No. of phases	Phase current A	Output kW	Input	Outputs C13	Outputs C19	PDU length mm	Minimum enclosure height mm	
1	16	3.6	C20	12	–	710	1200	7955.201
1	16	3.6	CEE	24	4	1225	1800	7955.210
1	32	7.2	CEE	24	4	1370	1800	7955.211
3	16	11	CEE	18	3	1100	1200	7955.231
3	16	11	CEE	24	6	1395	1800	7955.232
3	32	22	CEE	24	6	1620	2000	7955.233
3	32	22	CEE	36	6	1960	2200	7955.234
3	16	11	CEE	42	–	1665	2000	7955.235
3	32	22	CEE	48	–	2050	2200	7955.236
3	63	44	CEE	12	12	3 U	1200	7955.238

Power Distribution Unit

PDU international, switched version

Power			Pin patterns			Dimensions		Model No.
No. of phases	Phase current A	Output kW	Input	Outputs C13	Outputs C19	PDU length mm	Minimum enclosure height mm	
1	16	3.6	C20	12	–	775	1200	7955.301
1	16	3.6	CEE	24	4	1360	1800	7955.310
1	32	7.2	CEE	24	4	1400	1800	7955.311
3	16	11	CEE	18	3	1180	1800	7955.331
3	16	11	CEE	24	6	1480	1800	7955.332
3	32	22	CEE	24	6	1685	2000	7955.333
3	32	22	CEE	36	6	2065	2200	7955.334
3	16	11	CEE	42	–	1755	2000	7955.335
3	32	22	CEE	48	–	2110	2200	7955.336

PDU international, managed version

Power			Pin patterns			Dimensions		Model No.
No. of phases	Phase current A	Output kW	Input	Outputs C13	Outputs C19	PDU length mm	Minimum enclosure height mm	
1	16	3.6	C20	12	–	775	1200	7955.401
1	16	3.6	CEE	24	4	1360	1800	7955.410
1	32	7.2	CEE	24	4	1400	1800	7955.411
3	16	11	CEE	18	3	1180	1800	7955.431
3	16	11	CEE	24	6	1480	1800	7955.432
3	32	22	CEE	24	6	1685	2000	7955.433
3	32	22	CEE	36	6	2065	2200	7955.434
3	16	11	CEE	42	–	1755	2000	7955.435
3	32	22	CEE	48	–	2110	2200	7955.436

PDU accessories

	Packs of	Model No.
Covers for C13 jack, lockable	10 pc(s).	7955.010
Covers for C19 jack, lockable	10 pc(s).	7955.015
Connector, universal lock for C14/C20 connector	20 pc(s).	7955.020
Connection cable D/C19, 1.8 m	1 pc(s).	7200.216
Connection cable C19/C20, 1.8 m	1 pc(s).	7200.217

Rittal – The System.

Faster – better – everywhere.

- Enclosures
- Power Distribution
- Climate Control
- IT Infrastructure
- Software & Services

You can find the contact details of all Rittal companies throughout the world here.



www.rittal.com/contact

ENCLOSURES

POWER DISTRIBUTION

CLIMATE CONTROL

IT INFRASTRUCTURE

SOFTWARE & SERVICES



FRIEDHELM LOH GROUP